



MARLON

BAR CHAIR

Marlon by Pietro Franceschini. When pure geometry meets so curves, something sculptural and sensual comes out. A fine dialogue between oversized legs and clean lines takes place in this piece upholstered in mohair velvet. Marlon is edgy and elegant at the same time, letting the dilemma between 'contemporary' versus 'classical' fall apart.

Top

Fabric

Ring

Polished or satin brass, copper to nickel

Package Dimensions

23.6" x 27.5" x 39"

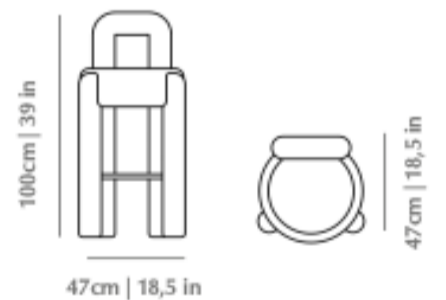

Seat Height: 30"

// as pictured

Upholstery - Gentle II 0733



COLLECTION

FABRIC CAT 1



Gentle 2 0113



Gentle 2 0733



Gentle 2 0753



Gentle 2 0673



Gentle 2 0873



Gentle 2 0783

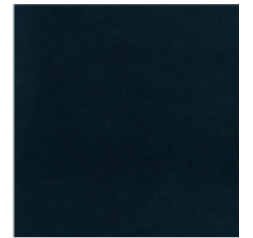

Gentle 2 0963



Gentle 2 0973

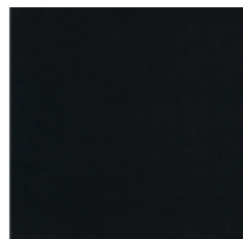

Gentle 2 0183

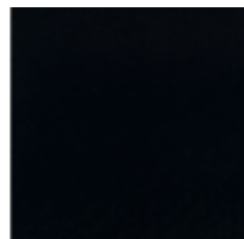

Gentle 2 0193



Gentle 2 0683



Gentle 2 0663

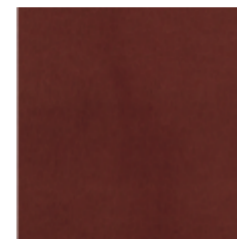

Gentle 2 0373



Gentle 2 0573



Gentle 2 0553



Gentle 2 0443

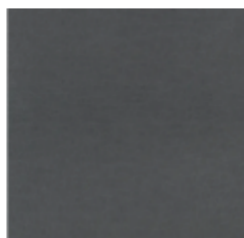

Gentle 2 0133



Gentle 2 0933



Gentle 2 0203



Gentle 2 0223



Gentle 2 0623

METALS - FOR RING



Polished Brass



Satin Brass



Polished Copper

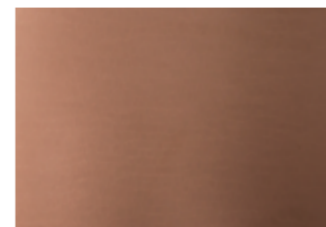

Satin Copper

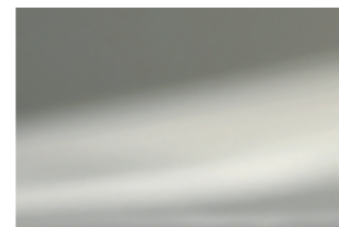

Polished Nickel

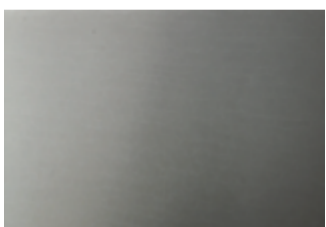

Satin Nickel